

turlens

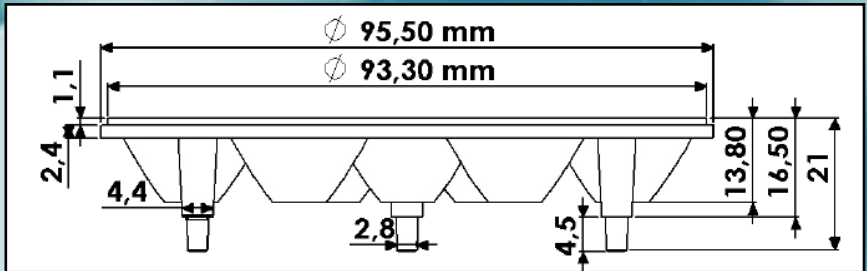

СЕРИЯ 9VL АРТИКУЛ:9В30D

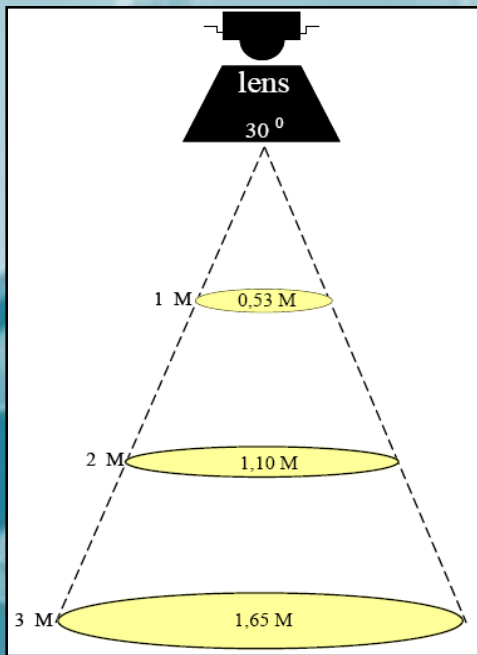
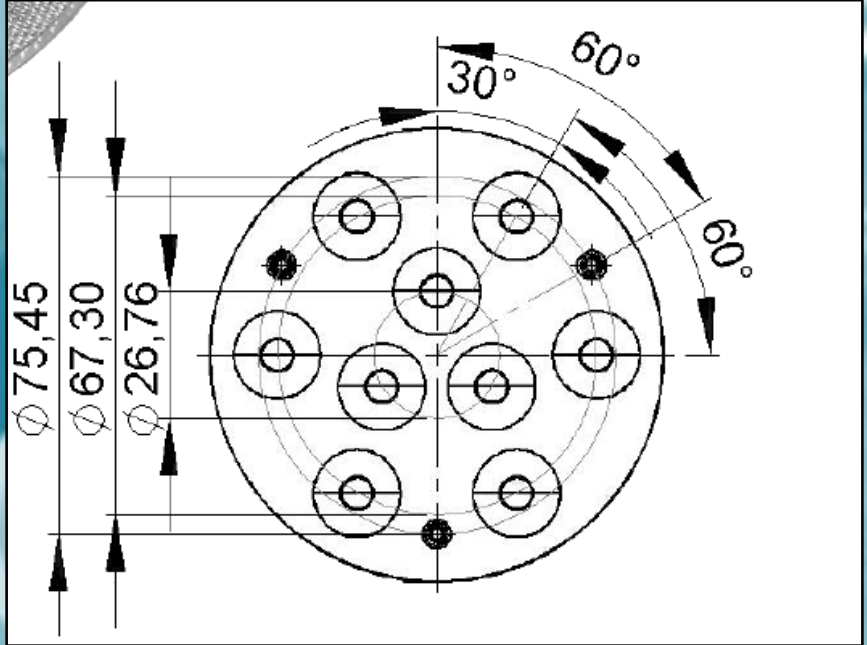
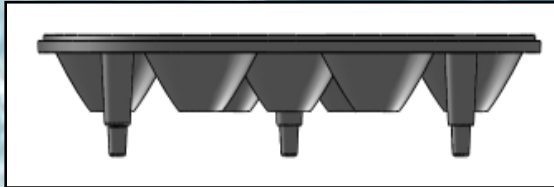
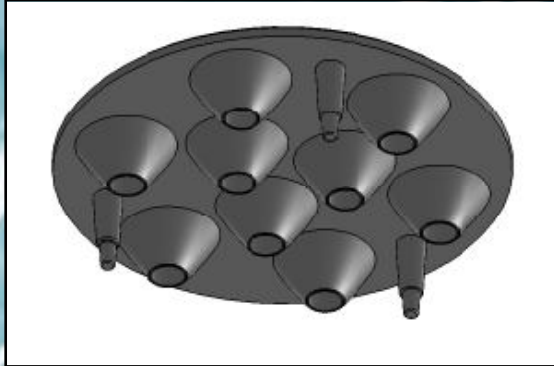

- МАТЕРИАЛ ЛИНЗЫ
- t° ИСПОЛЬЗОВАНИЯ ЛИНЗЫ
- КОЭФФИЦИЕНТ СВЕТОПРОПУСКАНИЯ (2мм)
- ДЕРЖАТЕЛЬ
- УПАКОВКА

OPTICAL GRADE PMMA
-40°-+105°С
92%
ТРИ НОЖКИ ПОД ЗАПАЙКУ
108шт.